



## Beam Clamp 1 Ton

### Características Esenciales

- 3 Años de Garantía, Partes y Servicios Disponibles en América

## Especificaciones Técnicas

<b>Capacidad de Carga</b>	1 Ton / 2200 lbs.   Test Load: 1.5 Rated Load	<b>Garantía</b>	3 Year
<b>Rango de ancho de la Viga</b>	10 in		

Working Load	I-Beam Width	A Max.	B		C	D	E	F		G	H
			Min.	Max.				Min.	Max.		
2200	3 - 8.5	10.25	7	14	2.5	0.19	8.5	4	6.1	1	0.86
4400	3 - 8.5	10.25	7	14	3	0.23	8.5	4	6.1	1	0.86
6600	3 - 12.5	14	9.25	19.25	4	0.31	10.2	5.5	8.85	1.8	0.94
11000	3 - 12.5	14	9.25	19.25	4.3	0.4	10.2	5.5	8.85	1.8	1.1

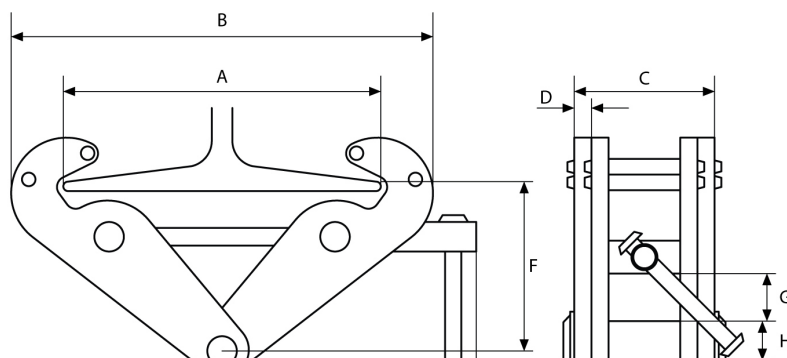

## Peso & Dimensiones

**Peso Total** 18 lbs / 9 Kg

## Detalles del Empaque

**Paquete 1 Peso Neto** 15 lbs / 7 Kg

**Paquete 1 Ancho** 7 in / 17.78 cm

**Paquete 1 Peso Bruto** 18 lbs / 8 Kg

**Paquete 1 Altura** 5 in / 12.7 cm

**Paquete 1 Profundidad** 18 in / 45.72 cm

Referential Images / Imágenes Referenciales  
Specifications may change without notice / las especificaciones pueden cambiar sin previo aviso