



Beam Clamp 3 Ton

Características Esenciales

- 3 Años de Garantía, Partes y Servicios Disponibles en América

Especificaciones Técnicas

Capacidad de Carga	3 Ton / 6600 lbs. Test Load: 1.5 Rated Load	Garantía	3 Year
Rango de ancho de la Viga	12.5		

Working Load	I-Beam Width	A Max.	B		C	D	E	F		G	H
			Min.	Max.				Min.	Max.		
2200	3 - 8.5	10.25	7	14	2.5	0.19	8.5	4	6.1	1	0.86
4400	3 - 8.5	10.25	7	14	3	0.23	8.5	4	6.1	1	0.86
6600	3 - 12.5	14	9.25	19.25	4	0.31	10.2	5.5	8.85	1.8	0.94
11000	3 - 12.5	14	9.25	19.25	4.3	0.4	10.2	5.5	8.85	1.8	1.1

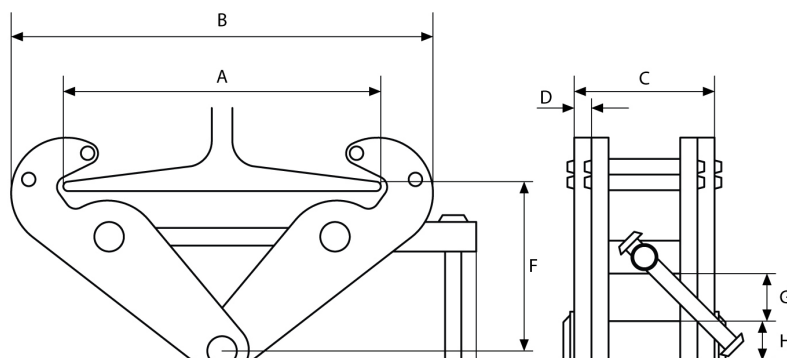

Peso & Dimensiones

Peso Total 18 lbs / 9 Kg

Detalles del Empaque

Paquete 1 Peso Neto 15 lbs / 7 Kg

Paquete 1 Ancho 11 in / 27.94 cm

Paquete 1 Peso Bruto 18 lbs / 8 Kg

Paquete 1 Altura 6 in / 15.24 cm

Paquete 1 Profundidad 22 in / 55.88 cm

Referential Images / Imágenes Referenciales
Specifications may change without notice / las especificaciones pueden cambiar sin previo aviso