

2 Ton Underhung Motorized End Trucks Single Girder up to 57ft Span 220/440V 3P

Características Esenciales

- I Beam and H Beam Compatible, Customizable up to 12" width Beams
- Kit Includes 2 End Trucks, 4 motors, 4 reducer, 4 Brakes
- Dual Voltage 220/440V 3 Phase, Optional Variable Speed Driver
- Fully Painted Orange RAL2009
- 3 Años de Garantía, Partes y Servicios Disponibles en América

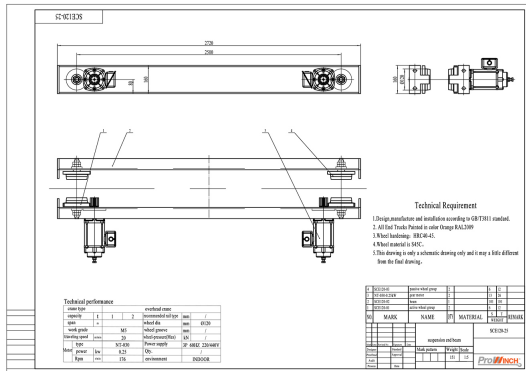

Especificaciones Técnicas

Capacidad de Carga	2 ton	Freno Motor	Yes
Velocidad /min	66 ft	Protección IEC Motor	IP54
Numero de Velocidades	1 Speed - Optional Variable Speed	Variador de Frecuencia	Optional 1.5 Kw
Voltaje	3 Phase 220~240/440~480V 60Hz	Freno Dinámico	Only with VFD Optional
Potencia Total Watts	0.25Kw x 4	Control	Not Included. Optional single Speed, 2 Speed and Variable Speed
Luz Maxima	60 ft	Rango de ancho de la Viga	110 - 300 mm (4.33 - 11.8 in)
Material	Steel	Normas	ASME / CMAA / Nch
Clase de Servicio	H4/M5/2m/Class D	Garantía	3 Year

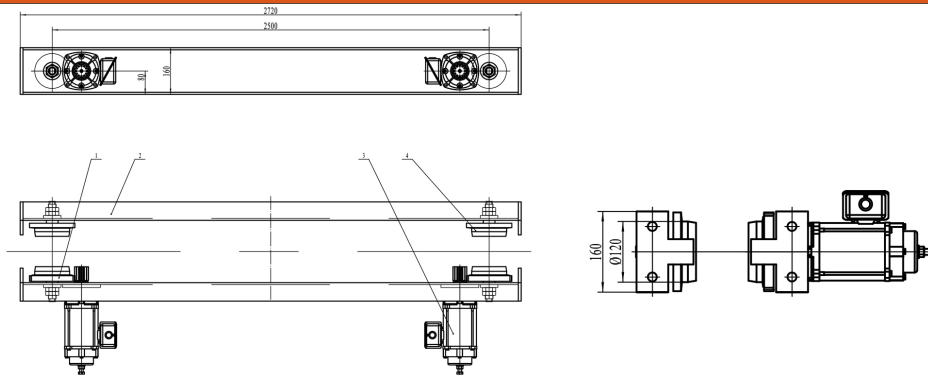

Peso & Dimensiones

Detalles del Empaque

Largo de testera 2500 mm

Paquete 1 Peso Bruto 256 lbs / 116 Kg

Peso Total 256 lbs / 117 Kg

Referential Images / Imágenes Referenciales
 Specifications may change without notice / las especificaciones pueden cambiar sin previo aviso